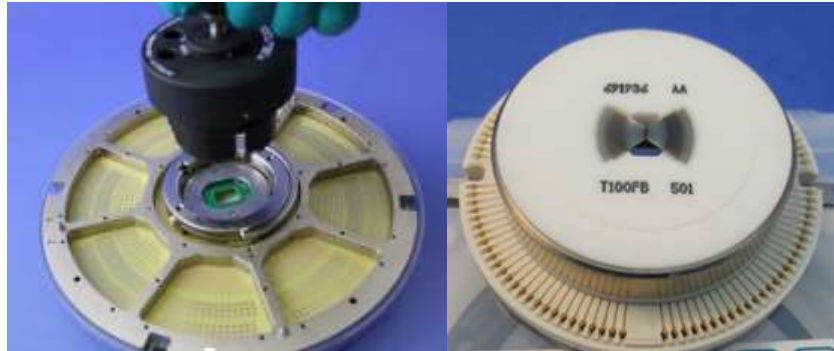

VC43E – Element Series 43mm Ceramic VersaCore**■ Description**

- The VC43E offers great versatility and adaptability.
- It can be quickly loaded and unloaded to be used across different test platforms easily.
 - MPPT
 - Verigy
 - Custom board with integrated VC43E footprint
- VC43E offers a Lab to Fab solution
- VC43E can be use in modeling & characterization, wafer level reliability, and or parametric testing.

■ Features

- Stable probing temperature -65° to 200°C
- Quick install/removal using insertion tool
- Low Cost of ownership
- Excellent life expectancy
- Low contact resistance less than 0.5 ohms out of the box
- Low leakage less than 5 fA/V pin to pin
- Capacitance 400fF
- Standard $\pm 5\mu\text{m}$ X, Y, and Z accuracy
- Up to 100 channels
- EEPROM/ID code options
- System diagnostic cores - shorted, resistor cores available

Design and specifications are each subject to change without notice. Please verify before purchase and/or use. Should a safety concern arise regarding this product, please notify Celadon Team.

- Explanation of Part Numbers:

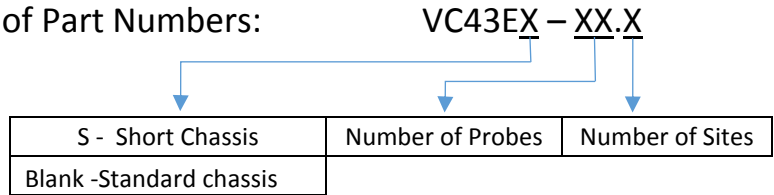

- Dimension

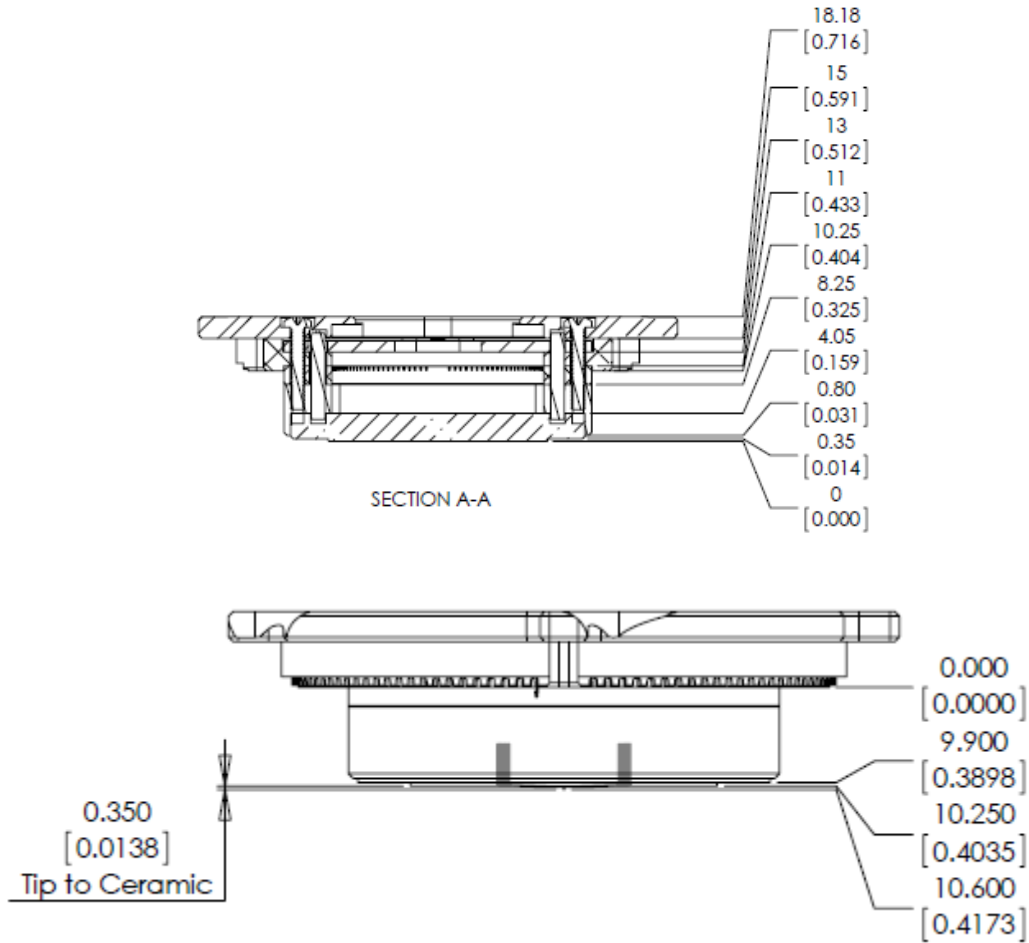

Design and specifications are each subject to change without notice. Please verify before purchase and/or use. Should a safety concern arise regarding this product, please notify Celadon Team.

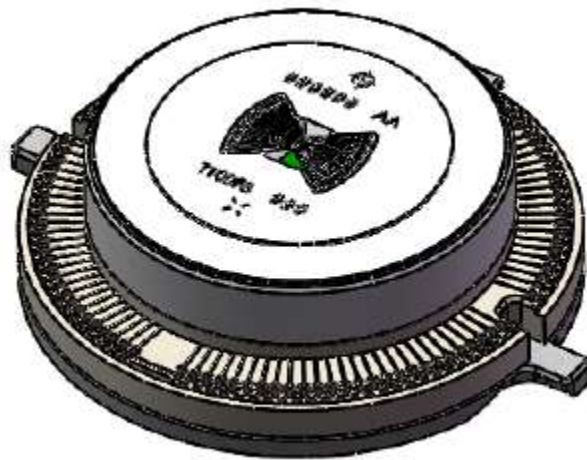
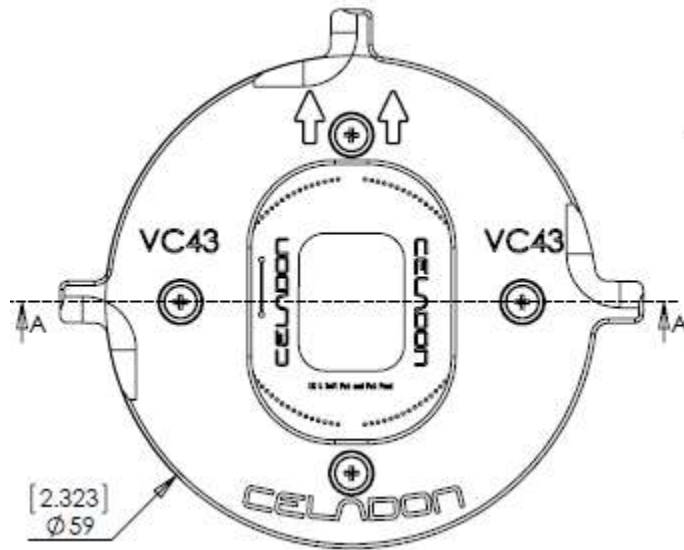

Design and specifications are each subject to change without notice. Please verify before purchase and/or use. Should a safety concern arise regarding this product, please notify Celadon Team.

- Leakage

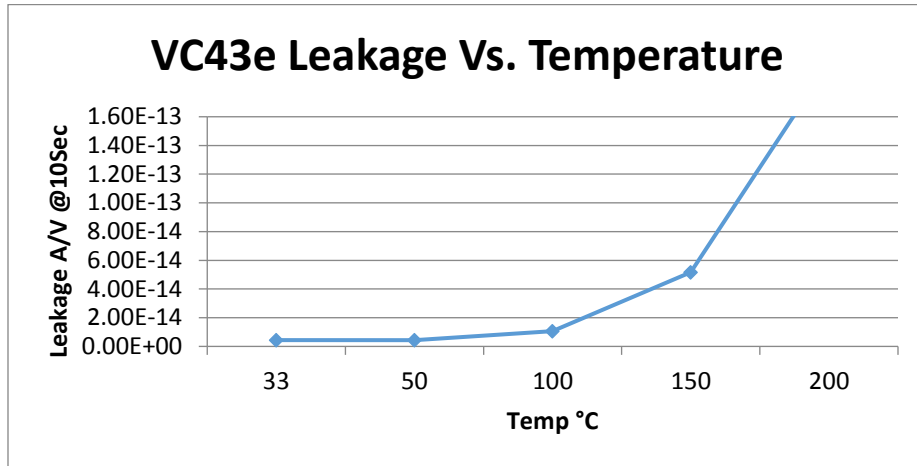

- Typical scrub on wafer

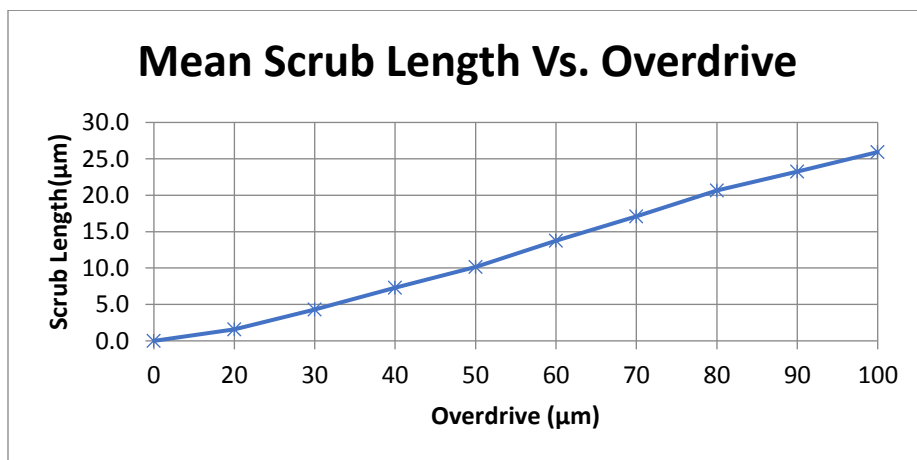

- Typical probe gram-force

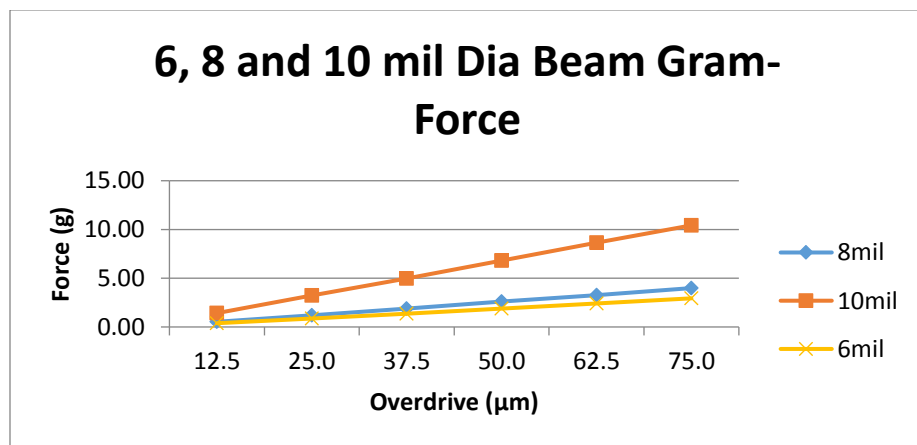

Design and specifications are each subject to change without notice. Please verify before purchase and/or use. Should a safety concern arise regarding this product, please notify Celadon Team.